



A Professional GSM Alarm System designer and manufacturer!
GSM SMS Controller Alarm & GSM House Alarm System &
GSM Telemetry Units & GSM GPRS Logging System
[Http://www.GSMalarmsystem.com](http://www.GSMalarmsystem.com) www.KingPigeon.Com.Cn

Remote switching machines with a SMS text from your mobile phone!

Remote Monitoring your assets in the worldwide by your mobile Phone!



GSM SMS Controller GSM SMS Alarm Unit

S130 S140 S150

User Manual

Ver 1.50 Date Issued: 2011-04-06

All rights reserved by King Pigeon Hi-Tech. Co., Ltd.

Website: [Http://www.GSMalarmsystem.com](http://www.GSMalarmsystem.com)



Table of contents

1.	Brief introduction -----	3
2.	Safety Directions -----	3
3.	Standard Packing list -----	4
4.	Physical Layout -----	4
5.	Features -----	5
6.	Settings -----	6
7.	Operation -----	9
8.	Installation -----	10
9.	Technical specifications -----	17
10.	Quality Warranty -----	17
11.	Trouble Shooting Guide-----	17

This handbook has been designed as a guide to the installation and operation of S130,S140,S150 GSM SMS Controllers. Statements contained in the handbook are general guidelines only and in no way are designed to supersede the instructions contained with other products.

We recommend that the advice of a registered electrician be sought before any Installation work commences.

King Pigeon Hi-Tech.Co., Ltd, its employees and distributors, accept no liability for any loss or damage including consequential damage due to reliance on any material contained in this handbook.

King Pigeon Hi-Tech.Co., Ltd, its employees and distributors, accept no liability for GSM Network upgrading or SIMCard upgrading due to the technology specifications contained in this handbook.

Model List

Model No.	Differences
S130	2 Digital inputs, 1 Alarm Link output relay, 1 independent output relay for SMS Commands.
S140	4 Digital inputs, 1 Alarm Link output relay, 1 independent output relay for SMS Commands.
S150	8 Digital inputs, 1 Alarm Link output relay, 1 independent output relay for SMS Commands.

Notice: The PC Configurator is free of charge, suitable for S130, S140, S150. For S130, only the input1 and input2 are valid; For S140, only the input1, input2, input3, input4 are valid. For S150, all inputs are valid.

SMS Command List

SMS COMMAND	Functions & Actions
AA	To arm the system, in this case, any detector triggered will alarm.
BB	To disarm the system, in this case, any detector triggered will not alarm.
CC	To switch ON the independent output relay
DD	To switch OFF the independent output relay
EE	Inquiry the GSM SMS Controller Status

***The commands should plus Password, the format is Password+SMS Command. i.e.: if the password is 1234, then you can send **1234AA** to arm, **1234BB** to disarm. The password can be modified by PC Configurator.**



1. Brief introduction

The GSM SMS Controller is a very simple device which can be used for authorized door access, controlling gates, switching of remote equipments, car parking systems. Actually the GSM SMS Controller can be used in places which require turning ON/OFF your system, machines, and equipments remotely with a SMS text from your mobile phone and protect your assets.

Moreover, the GSM SMS Controller with multi-digital inputs for digital inputs, when any one of the inputs triggered, will start the siren or switch on the light automatically. In the meanwhile, the GSM SMS Controller will send SMS Alert to the owners immediately. This is very useful if you need protect your assets with low cost solution.

The GSM SMS Controller suitable for below applications:

1. Security Alarm System applications;
2. Supervision and monitoring alarm systems;
3. Automatic monitoring system;
4. Vending Machines security protection;
5. Pumping Stations, Tanks, Oil or Water levels;
6. Buildings and Real Estate;
7. Weather Stations;
8. River Monitoring and Flood Control;
9. Oil and gas pipelines;
10. Corrosion protection
11. Temperatures, water leakage applications;
12. Wellheads, boat, vehicle;
13. Energy saving, street lights control system;
14. Valve controls;
15. Transformer stations;
16. Unmanned machine rooms;
17. Control room application;
18. Automation System, M2M;
19. GSM Access Control System, GSM Gate Opener, etc.

2. Safety Directions



Safe Startup

Do not use GSM SMS Controller when using GSM equipment is prohibited or might bring disturbance or danger.



Interference

All wireless equipment might interfere network signals of GSM SMS Controller and influence its performance.



Avoid Use at Gas Station

Do not use GSM SMS Controller at a gas station. Power off GSM SMS Controller when it near fuels or chemicals.



Power it off near Blasting Places

Please follow relevant restrictive regulations. Avoid using the device in blasting places.



Reasonable Use

Please install the product at suitable places as described in the product documentation. Avoid signal shielded by covering the mainframe.



Use Qualified Maintenance Service

Maintenance can be carried out only by qualified maintainer.

3. Standard Packing List

Control Unit X1, GSM ANT X1, PC Configurator and User Manual X1(CD), Connectors, AC/DC Adaptor X1.

Optional Accessories: (Wired Detectors)

PIR Motion Detector, Glass Break Detector, Magnetic Window Detector, Temperature Detector, Infrared Beam Fence, Vibration detector, Water level detector, Siren, etc.

4. Physical Layout

4.1 Control Unit physical layout

LED Instruction



GSM RELAY STATUS ALARM

GSM	GSM Module indicator, registering will quickly flick, registered successful will slowly flick.
RELAY	Output relay indicator, when any output relay closed, it will be on; when relay opened, it will be off.
STATUS	Arm Indicator, on is armed, off is disarmed;
Alarm	Alarm Indicator, on is alarming, off is normally;



Interface 1 Instruction

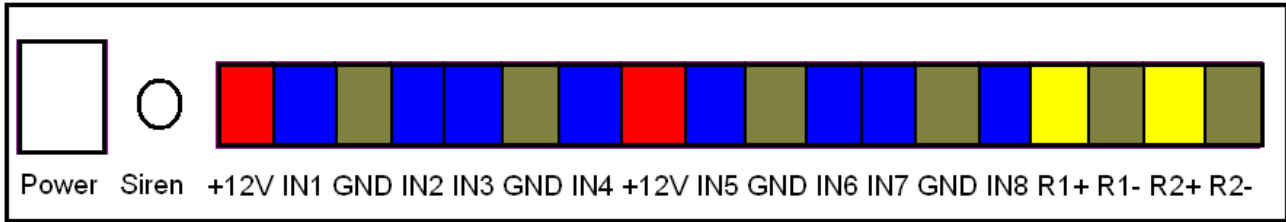

MIC	For listening in the sounds around the GSM SMS Controllers while alarm, the Microphone is needn't power, it is the same type for the computer.
SPK	For two way voice communication. When the authorized numbers dial in, the unit will check the incoming number, if matched, then can create two-way voice communication.
GSM ANT	Connect the GSM ANT, if the GSM signal is not strong; please change the 3dB GSM ANT.
USB	Connect to the computer, for setup the unit parameters.

Interface 2 Instruction

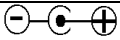

POWER	External Power Connector, Connect to 2A@12V DC power through AC/DC Adaptor. 
SIREN	Will start for 60seconds when alarm. The siren or strobe siren should be <12V DC. 
+12V	+12VDC@1A power output for wired detectors.
IN1	Digital input 1, connect to one wire of the wired Detector.
GND	Ground point; connect to another wire of the wired Detector or -12VDC.
IN2	Digital input 2, connect to one wire of the wired Detector.
IN3	Digital input 3, connect to one wire of the wired Detector.
GND	Ground point; connect to another wire of the wired Detector.
IN4	Digital input 4, connect to one wire of the wired Detector.
+12V	+12VDC@1A power output for wired detectors.
IN5	Digital input 5, connect to one wire of the wired Detector.
GND	Ground point; connect to another wire of the wired Detector or -12VDC.
IN6	Digital input 6, connect to one wire of the wired Detector.
IN7	Digital input7, connect to another wire of the wired Detector.
GND	Ground point; connect to another wire of the wired Detector.
IN8	Digital input 8, connect to one wire of the wired Detector.
R1+	Alarm-Link Output Relay. Built in 240VAC@3A rated relay output, connect to the device positive electrode. Alarm-Link Output Relay.
R1-	Alarm-Link Output Relay. Built in 240VAC@3A rated relay output, connect to the device negative electrode. Alarm-Link Output Relay.
R2+	Independent Output Relay. Built in 240VAC@3A rated relay output, connect to the device positive electrode.
R2-	Independent Output Relay. Built in 240VAC@3A rated relay output, connect to the device negative electrode.

5. Features

- 1 Independent Output Relay (240VAC@3A) can be switched ON/OFF by sending a SMS text;
- 1 Alarm-Link Output Relay (240VAC@3A) can be switch on 0-120minutes if controller unit triggered;



3. 2/4/8 Alarm logic digital inputs, NC or NO and EOL is optional;
4. 3 SMS Alert numbers and 5 Alarm dial Telephone numbers can accept to the alarm message;
5. Two-way voice communication by external microphone and speaker;
6. Supports armed, disarmed, inquiry status, switch on or off Independent Output Relay by SMS Commands;
7. Password protected, prevents unauthorized user;
8. Can be set up and programmed from PC Configurator by USB cable;
9. Time stamped alarm messages.
10. Backup rechargeable battery inside, can work for 24hours when AC Power goes off.
11. Can be operated from anywhere, no distance limit;
12. Based on GSM Network, applied to many applications.

6. Settings

The GSM SMS Controller is for user-friendly design. The user can setup it by the PC Configurator through USB cable. The GSM SMS Controller can not be configured parameters by SMS Commands.

Tips!

- 1) *In order to forbidden the intruders switch off the unit, we equipped the power switch inside, it is nearby the SIMCard socket, please pay attention to it, and don't tell others of this. Turn it towards inside is off, turn it towards outside is on. And when setup the unit, please put the Setting switch to SET position, after setup, switch it to WORK Position. Please see below photo.*

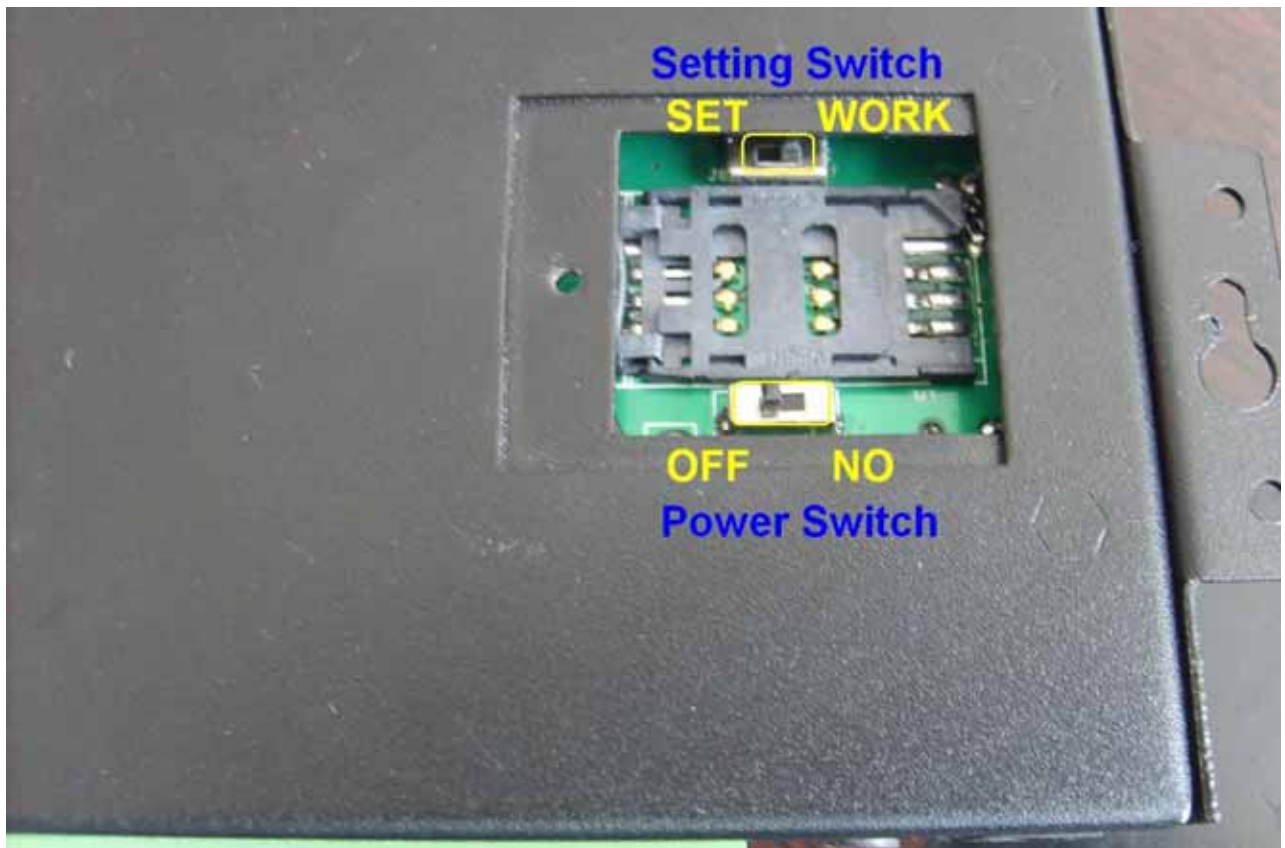

- 2) *Please insert the SIMCard firstly, and install the GSM Antenna, please power on to check the LEDs can work or not, then switch off it before you program it by PC Configurator.*
- 3) *The default password is 1234, you can modify it by enter the new password in the PC Configurator.*



- 4) Two way communication: While the authorized users incoming call, the GSM SMS Controller unit will automatically answer the call, then the two-way voice communication will be created. If you want to test the two way voice communication, please make sure the other phone is away from the GSM SMS Controller unit at least 500meters. Otherwise, the near-cross will make lots of noise interference.
- 5) When the present alarming hasn't finished, the GSM SMS Controller will not handle the next alarm event till the present alarming finished. If the present alarming had finished, and the next alarm event still in alarming condition, the GSM SMS Controller will handle it.
- 6) When AC Power goes off, the Relay will not work. And the 12VDC power source for the detectors in the Board will be invalid.

The PC Configurator Interface

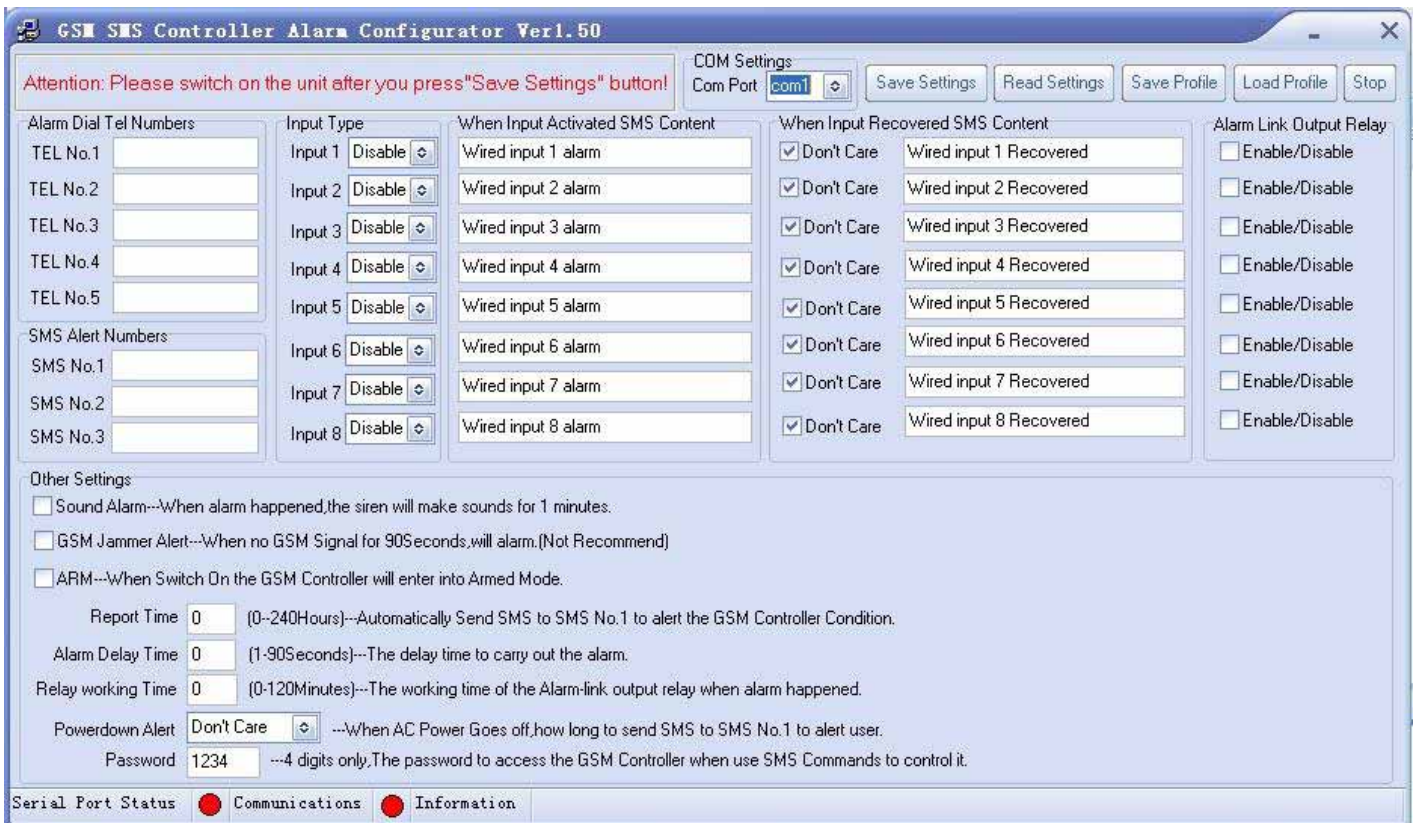

Please following the below steps one by one to setup it, otherwise you can not setup it successfully.

Step1: Please Contact the unit to the PC, and then install the USB Driver to the computer from the CD firstly. When successful, it can be found out at the device manager of the XP or Windows 7, please see the below photo. And remember the COM port. Also, the driver can be downloaded from Silicon Laboratories, Inc., the model is CP210x.

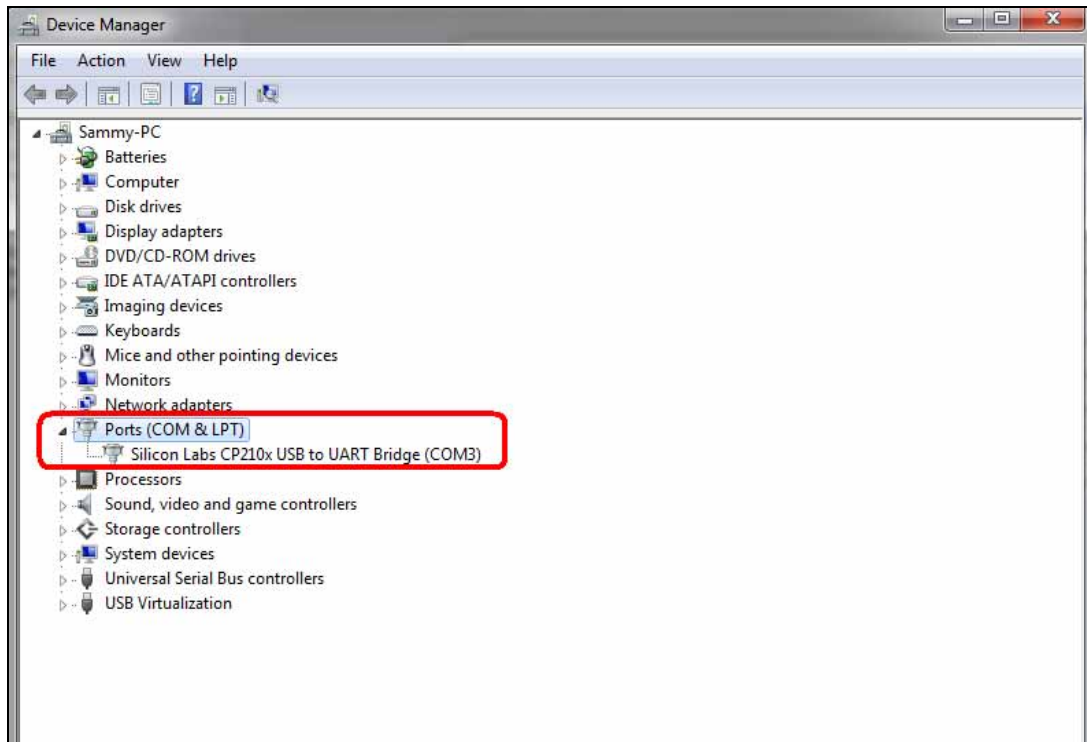

If the Com port is not Com1~Com5, then please right click the Device, then enter the Properties to change it, see below photos, after you changed it, and please restart the computer.

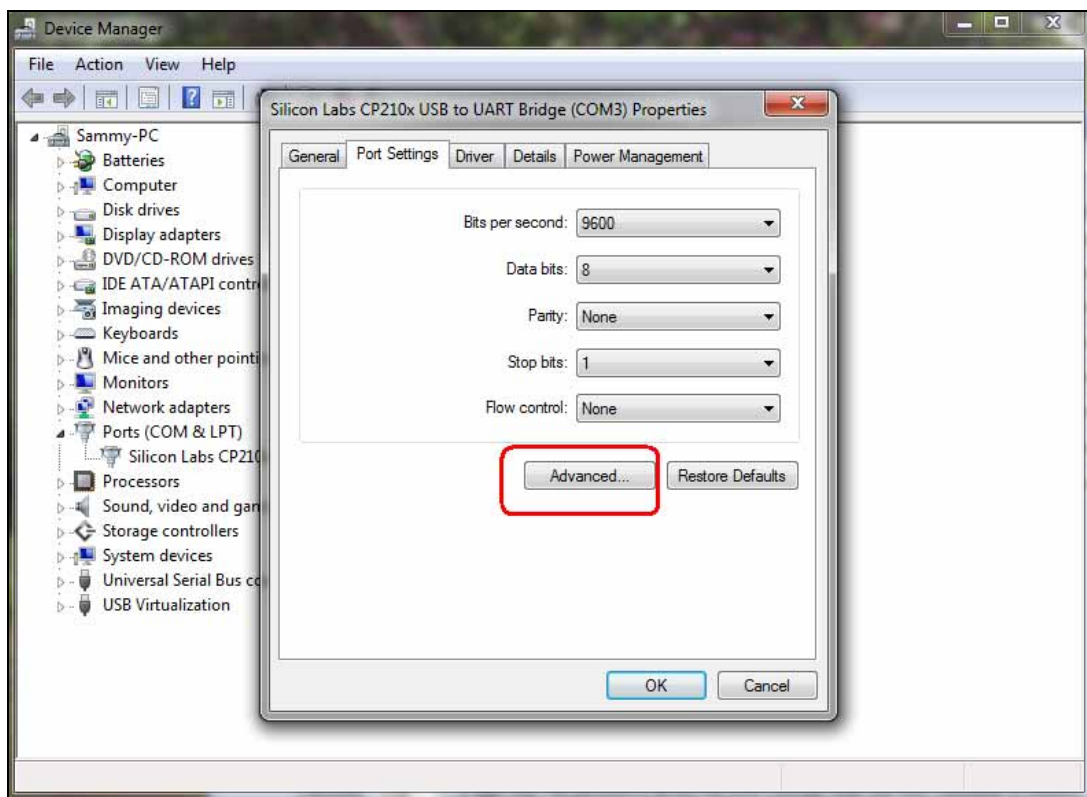

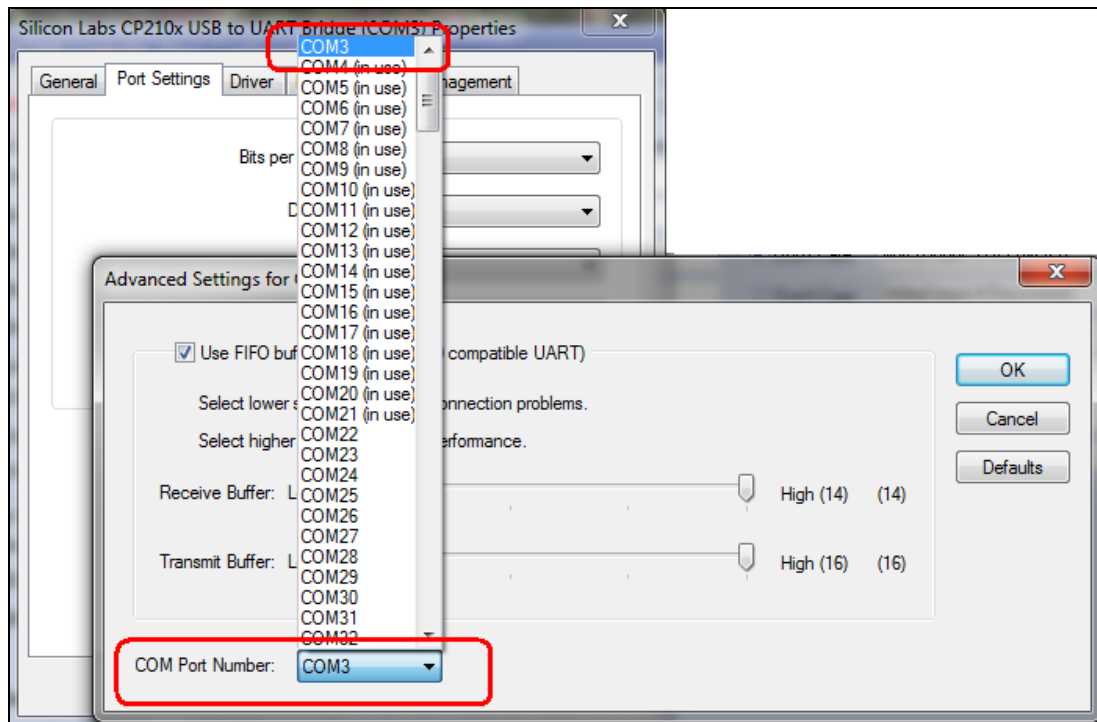

Step2: Please insert the SIMCard into the GSM SMS Controller carefully;

Step3: Please running the PC Configurator, needn't installed it;

Step4: Please connect the GSM SMS Controller to the computer through USB cable, but please don't switch on the GSM SMS Controller, otherwise, the setup will be failure;

Step5: Please setup the GSM SMS Controller parameters, the details please see below **Function Table 1**;

Step6: After you finished the setup, then press **"Save Settings"** button then switch on the GSM SMS controller, after 2Seconds, it will alert the Setup successful. If it hasn't prompted the setup successful, it means the setup is failure, please check the Com port and USB connection. You can change the Com Port to try it one by one, if the Communication LED sign is green after you press the **"Save Settings"**, it means the Com port is correct, otherwise, it is incorrect, please use the dropdown menu to change it.

Step 7: Switch off the unit then remove the USB cable, and Switch on the Unit to finish the setup.

If it hasn't prompted the setup successful, it means the setup is failure, please check the Com port and USB connection, then try to repeat the Step1~Step6 again.

Function Table 1

Items	Description
Com Setting	Select the Com port to communicate between GSM SMS Controller and Computer.
Save Settings	Save the present settings from computer to GSM SMS Controller.
Read Settings	Read the GSM SMS Controller present settings to computer.



A Professional GSM Alarm System designer and manufacturer!
GSM SMS Controller Alarm & GSM House Alarm System &
GSM Telemetry Units & GSM GPRS Logging System
[Http://www.GSMalarmssystem.com](http://www.GSMalarmssystem.com) www.KingPigeon.Com.Cn

Save Profile	Save the present settings from computer as a file.
Load Profile	Load the settings from the Saved file in the computer.
Stop	Stop the communication between the computer and GSM Controller.
Alarm Dial Tel. Numbers	Please add the country code, e.g.: +86 or 0086 in China. When alarm, the unit will call these numbers one by one after sent out SMS Alarm message. Please see below tips.
SMS Alert Numbers	Please add the country code, e.g.:+86 or 0086 in China. When alarm, the unit will send related Digital Input SMS Alert Content to these numbers one by one firstly.
Input Type	Disable: Means this input is invalid; NC: Normal Close, open will alarm; NO: Normal Open, close will alarm; EOL: End of Line, Means must be connected with a 2.2K resistor between the GSM SMS controller and digital detector. See installation diagram.
When Input Activated SMS Alert Contents	These words or sentences will be sent to the SMS Alert Numbers once the related inputs triggered. Max. Characters: 34. If the inputs keep the triggered status, the GSM SMS Controller will handle it as one alarm case, will stop to send SMS Alarm message till the inputs recovered and triggered again. This is very useful for the detectors continue keep the triggered status, like temperature detector, water level detectors, etc.
When Input Recovered SMS Alert Contents	These words or sentences will be sent to the SMS Alert Numbers once the related inputs recovered. Max. Characters: 34. If you tick the Don't Care means when this input recovered, will not send SMS to SMS Alert Numbers. If you like to get SMS alert when the Inputs recovered, then please don't tick it, in this condition, the GSM SMS Controller only send SMS to all SMS Alert Numbers, will not dial the Alarm Dial Tel. Numbers. This is very useful for owners to know when the inputs recovered, like temperature detector, water level detectors, etc.
Alarm Link Output Relay	Tick it to setup when this input triggered, the alarm link output relay should close, the relay close time according to Relay Working Time . Otherwise, the alarm link output relay will not close.
Sound Alarm	Tick it to setup the siren make sounds for 60 seconds when Alarm occurrence.
GSM Jammer	Tick it to setup when the unit detected no GSM signal for more than 90 seconds, the siren should sound 60seconds, and alarm-link output relay close 4minutes.(Don't recommend)
Arm	Tick it to setup the unit to arm mode once power on. In this case, any detector triggered will alarm. The system will send out the preset SMS text to SMS alert numbers, and dial the Alarm Dial Tel. Numbers one by one, in the meantime, the siren will sound 60seconds and the alarm-link output relay will close, the relay close time according to Relay Working Time . Otherwise, the system will in disarmed mode after power on.
Report Time	Fill it to setup the Report time gap, Range: 0~240Hours. The unit will automatically send its status to the 1 st SMS alert numbers according to this setting. Only in Armed mode is valid.
Alarm Delay Time	To setup the delay time after any input triggered. The range is 0~90Seconds.
Relay Working Time	To setup the Alarm-Link Output Relay Close time when alarm happened. The range is 0~120Minutes.
Power Down Alert	To setup when AC power goes off, how long to send SMS to the 1 st SMS Alert Number. Don't Care means when AC Power goes off will not send SMS to the 1 st SMS Alert Number. Immediacy Means will send SMS to the 1 st SMS Alert Number immediately. When AC goes on, the GSM SMS Controller will send SMS to 1 st SMS Alert Number.
Password	To verify the SMS commands from the authorized users and modify new password.



Notice:

1. In some GSM operators they use different SMS protocols, if the unit can't return the SMS confirmation is normally. It is not product problem. Also, you can try to add the country code before the number, see the below settings:

For example:

In China, the country code is **+86**, or **0086**.

The user cell phone number is **13570810254** and has been assigned as a SMS Alert number, the simcard number in the panel is **13512345678**.

Problem 1: Alarm but the user hasn't received the SMS Alert.

Solution: Please plus the country code while you setup the 13570810254 as SMS Alert number, means setup **+8613570810254** to instead of the **13570810254**.

Problem 2: The user number can receive the SMS Alert message from alarm panel, but the alarm panel can not receive the commands from the user number.

Solution: Please add country code to the SIMCard number in the alarm panel. Means send sms commands to **+8613512345678** to instead of **13512345678**.

Solution 3: When you use cell phone dial another one, what number it will be displayed then you can set the displayed number as dial numbers; when you use cell phone send SMS to another cell phone, what number it will be displayed then you can set the displayed number as SMS Alert number, just use the "+" to replace the "00", also, you can try the "00".

7. Operating Instructions

The users can Arm/Disarm/Inquiry system status, Switch on or off the independent output relay by sending SMS Commands to the Control unit. The SMS Commands are below:

Notice:

The system will carry out the commands immediately (with no delay) after the Control Unit receive this SMS commands.

7.1 Armed

xxxxAA

"xxxx" stands for the password
(1-4 digits).

Return SMS

Armed Mode activated.

Example

1234AA

When the Password is 1234

7.2 Disarm

xxxxBB

"xxxx" stands for the password
(1-4 digits).

Return SMS

System deactivated.

Example

1111BB

When the Password is 1111

7.3 Switch On the independent output relay



xxxxCC
 "xxxx" stands for the password
 (1-4 digits).
 Return SMS
 Output Relay Closed.

Example
 1111CC
 When the Password is 1111

7.4 Switch OFF the independent output relay

xxxxDD
 "xxxx" stands for the password
 (1-4 digits).
 Return SMS
 Output Relay Opened.

Example
 1111DD
 When the Password is 1111

7.5 Inquiry System Status

xxxxEE
 "xxxx" stands for the password (1-4 digits).
 Return SMS
 Armed or At House or Disarmed
 AC Power is Ok or AC Power is failed
 GSM Value is 17 or other value
 Output Relay is Closed or Output Relay is opened

Notice:

The Output relay status in the Return SMS is the independent output relay status. It is not the alarm link Output Relay Status.

8. Installation

Before installing the control unit and detectors and sirens, please help to test the system firstly, including wired detector, power supply, gsm signal, etc.

8.1 Insert SIMcard into Control Unit

In the backside of the control unit, please install the GSM SIM card . The GSM ANT must be Vertical installation to ensure it in good working condition.

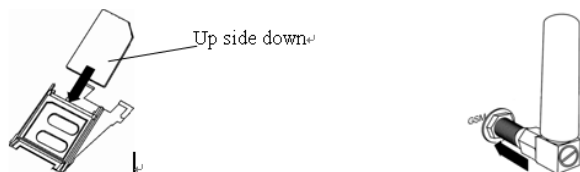

8.2 Connecting the Wired Detectors and Electricity equipments

Please help to see below wiring diagram, then fixed the related wired detectors; the detectors connect to the related digital inputs.

Tips!

- 1) Please setup the Disable(Default), NC, NO, EOL type in the PC Configurator correctly;
- 2) If you setup the input type as Disable (Default), then the input port will be invalid. We recommend customer setup the no-use input port as Disable type.
- 3) If you setup the input type as NC, the detector type must be NC, and if more than one detector contact to one input port, they're must be in series connection. Please see below diagram.

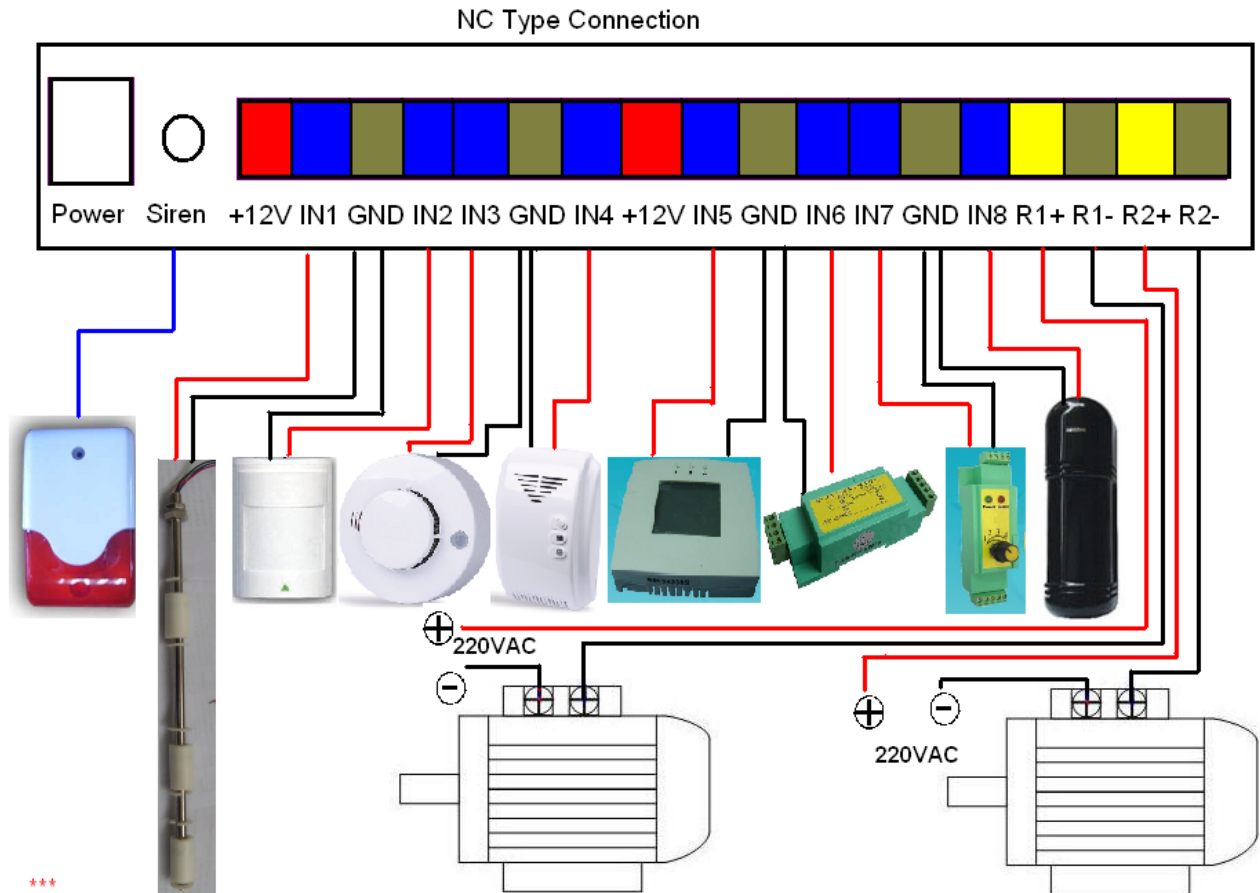

1. The two +12V are power source for wired sensors;
2. The R1+ R1- is the alarm link output relay;
3. The R2+ R2- is a separate output relay, which can be switched ON/OFF by SMS Commands.
4. The no-use inputs must be **set as Disable**

- 4) If you setup the input type as NO, the detector type must be NO, and if more than one detector contact to one input port, they're must be in parallel connection. Please see the below diagram.

NO Type Connection

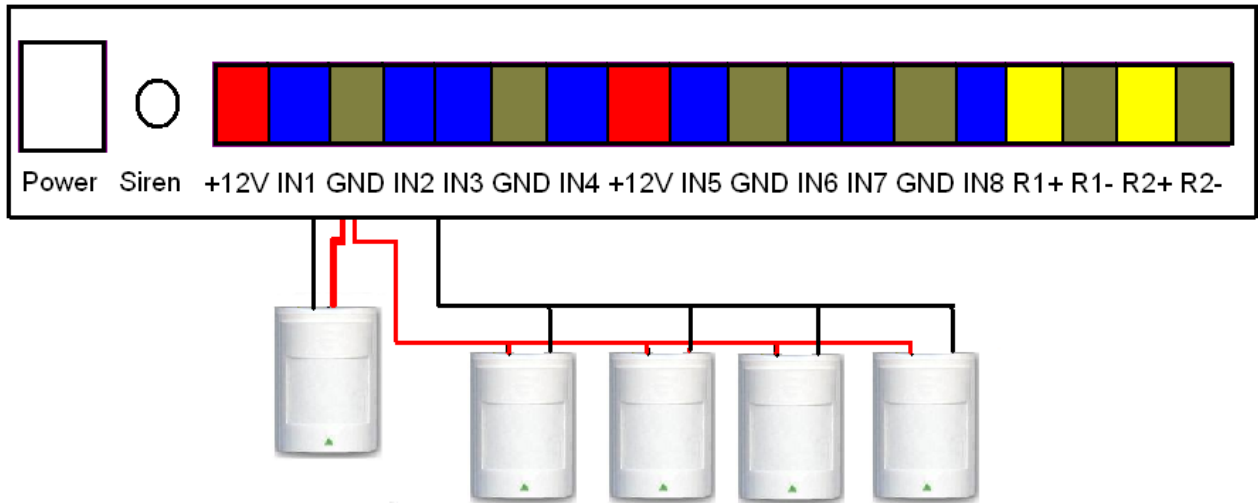

- 5) If you setup the input type as EOL, (This type is very useful to monitor the detectors connection condition; intruders cut the detectors' wires.)
- a) if the detector is NC type, then must be in series connection with a 2.2K Resistor;
 - b) if more than one NC detector contact to one input port, all detectors are NC type, and must be in series connection with a 2.2K Resistor, the 2.2K Resistor must be placed in the last detector. Please see the below diagram.

NC EOL Type Connections

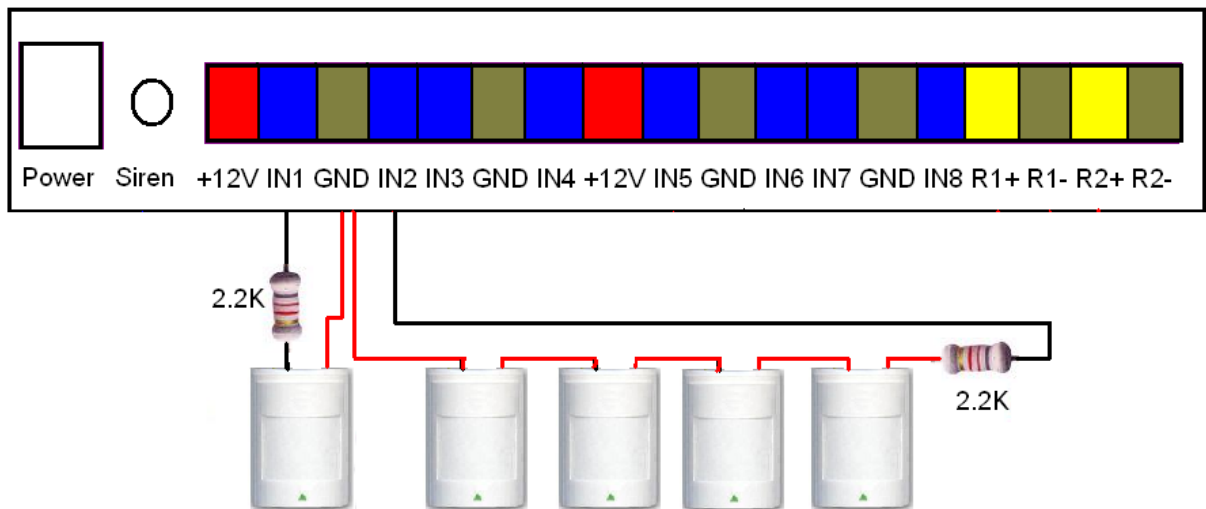

- c) if the detector is NO type, then must be in parallel connection with a 2.2K Resistor;
- d) if more than one NO detector contact to one input port, all detectors are NO type, and must be in parallel connection with a 2.2K Resistor, the 2.2K Resistor must be placed in the last detector. Please see the below diagram.

NO EOL Type Connections

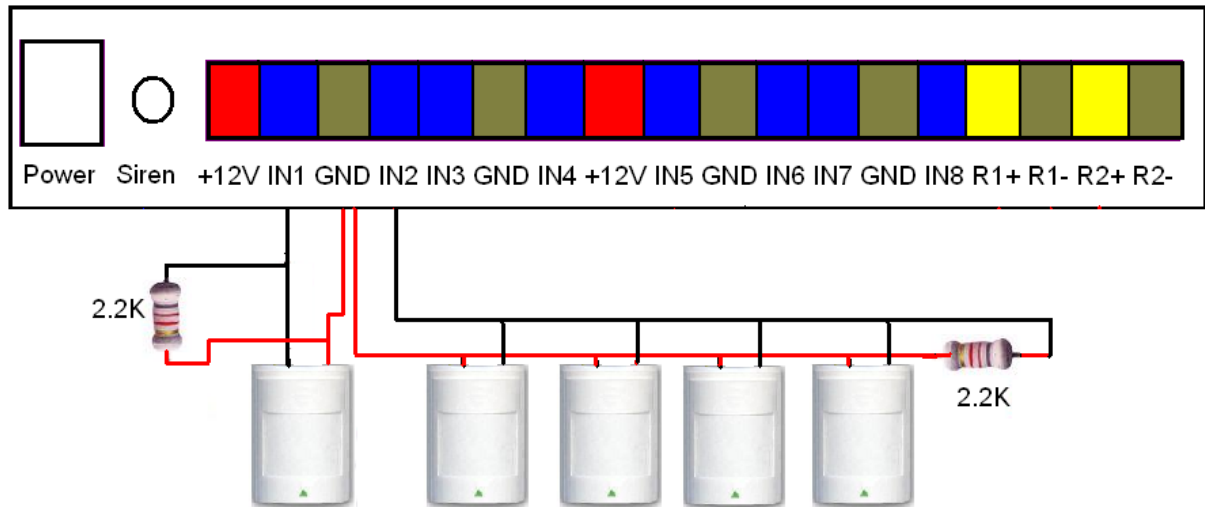

- 6) The Unit built-in 2 240VAC@3A rated relays. Please make sure the power cord rated while you connect to equipment device. Also, please make sure the power consumption is less than 250W for long time working (Approximate 2Hours). If you need heavy equipment, please connect an additional relay ;(Notice: When AC Power goes off, the Relay will not work.)
- 7) The R1+ and R1- are for alarm-link output relay, when the system alarm, will close, the relay close time according to **Relay Working Time**. The rated output power is 700W. If you need heavy equipment, please connect an additional relay.
- 8) The R2+ and R2- are the output relay for SMS Command, CC is close, DD is open, and EE is inquiry the status.
- 9) The +12VDC is for the Detectors, if the detectors need 12VDC power, then please contact it to the +12VDC. The 12VDC power is from external power, not from backup battery. So please note: When AC power failure, the +12VDC point will no power supply.

8.3 Typical application

One of the typical applications of the GSM SMS Controller is for automatically water tank monitoring and control solution. Please help to see below diagram. Also it can use to lots of other solutions. E.g.:

1. Security Alarm System applications;
2. Supervision and monitoring alarm systems;
3. Automatic monitoring system;
4. Vending Machines security protection;
5. Pumping Stations, Tanks, Oil or Water levels;
6. Buildings and Real Estate;
7. Weather Stations, River Monitoring and Flood Control;
8. Oil and gas pipelines, Corrosion protection
9. Temperatures, water leakage applications, Wellheads, boat, vehicle;
10. Energy saving, street lights control system, Valve controls;
11. Transformer stations;
12. Unmanned machine rooms, Control room application;
13. Automation System, M2M;
14. GSM Access Control System, GSM Gate Opener, etc.

Application Sample 1

Long Distance Automatically Water/Oil Tank Monitoring and Control Solution

This solution is suitable for the tank far away the Pump Motor, the water level detector can use other

types. Also, the user can use the SMS Command to switch on or switch off the Pump motor when use the independent output relay. This solution is suitable for lots of other similar monitoring applications.

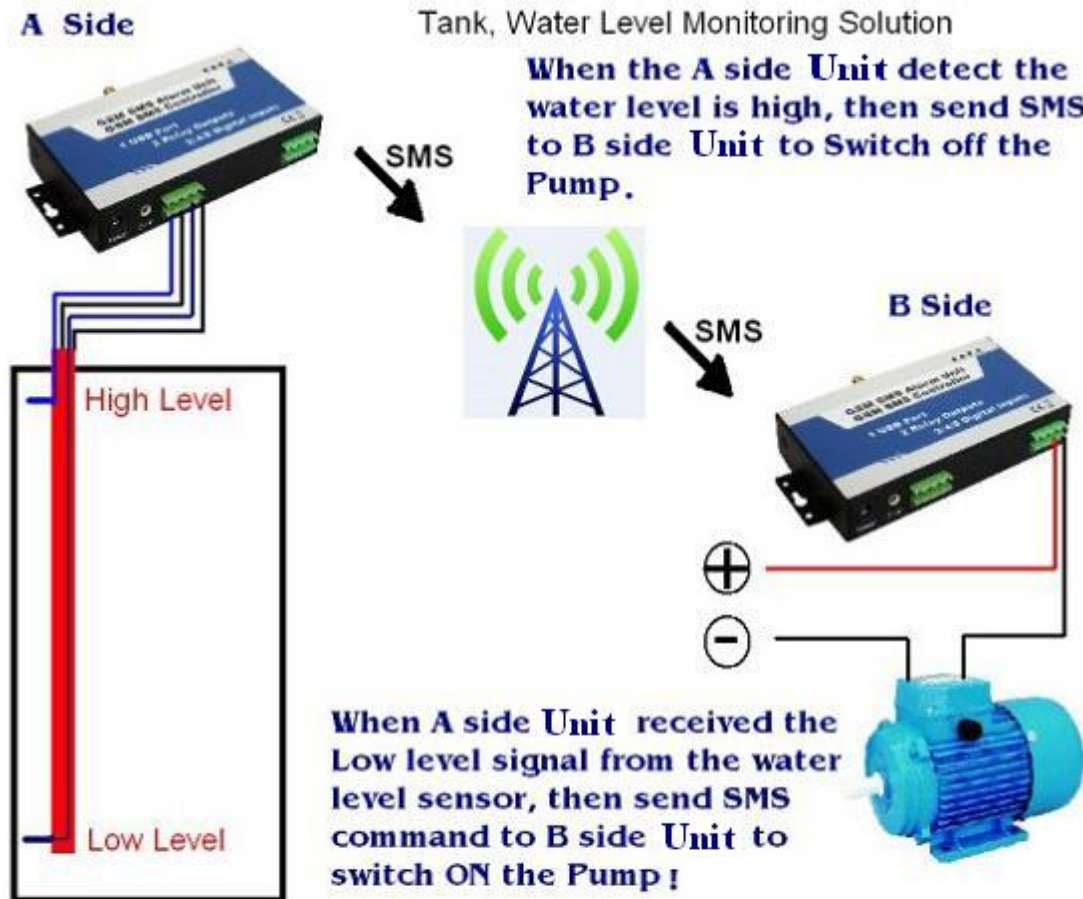

Method:

1. Use the **Water Level Sensor** to detect the water level, it can detect the low level and high level, 2 wires for low level, connecting to Input 1, 2 wires for high level, connecting to Input 2.
2. Set the SIMcard Number in B side Unit as the first SMS alarm number in A side Unit, and modify the SMS Alert content as "CC" to input 1, "DD" to input 2. so when Low level detected, the A side Unit will send CC command to B side Unit to switch ON the Pump, when high level detected, will send DD to B side Unit to switch OFF the Pump!

Explanation:

- 1) Use the water level detector (WL-04) to detect the water level, it can detect the low level and high level, two wires for low level, connecting to input 1, two wires for high level, connecting to input 2.
- 2) Set the SIMCard Number in B side GSM SMS Controller as the first SMS Alarm number in A side GSM SMS Controller, and modify the SMS Alert content as **1234CC** (1234 stands for password) to input 1, **1234DD** to input 2. So when Low level detected, the A side GSM SMS Controller will send **1234CC** command to B side GSM SMS Controller to switch ON the Pump, when high level detected, will send **1234DD** to B side GSM SMS Controller to Switch OFF the Pump. Means the A side alarm SMS message as the B side GSM SMS Controller Command.

Application Sample 2

Local Automatically Water/Oil Tank Monitoring and Control Solution

This solution is suitable for the tank nearby the Pump motor, and the owner know how many minutes that the pump motor can fill the water to the high level. The water level detector can use other types. Also, the user can use the SMS Command to switch on or switch off the Pump motor when use the independent output relay. This solution is suitable for lots of other similar monitoring applications.

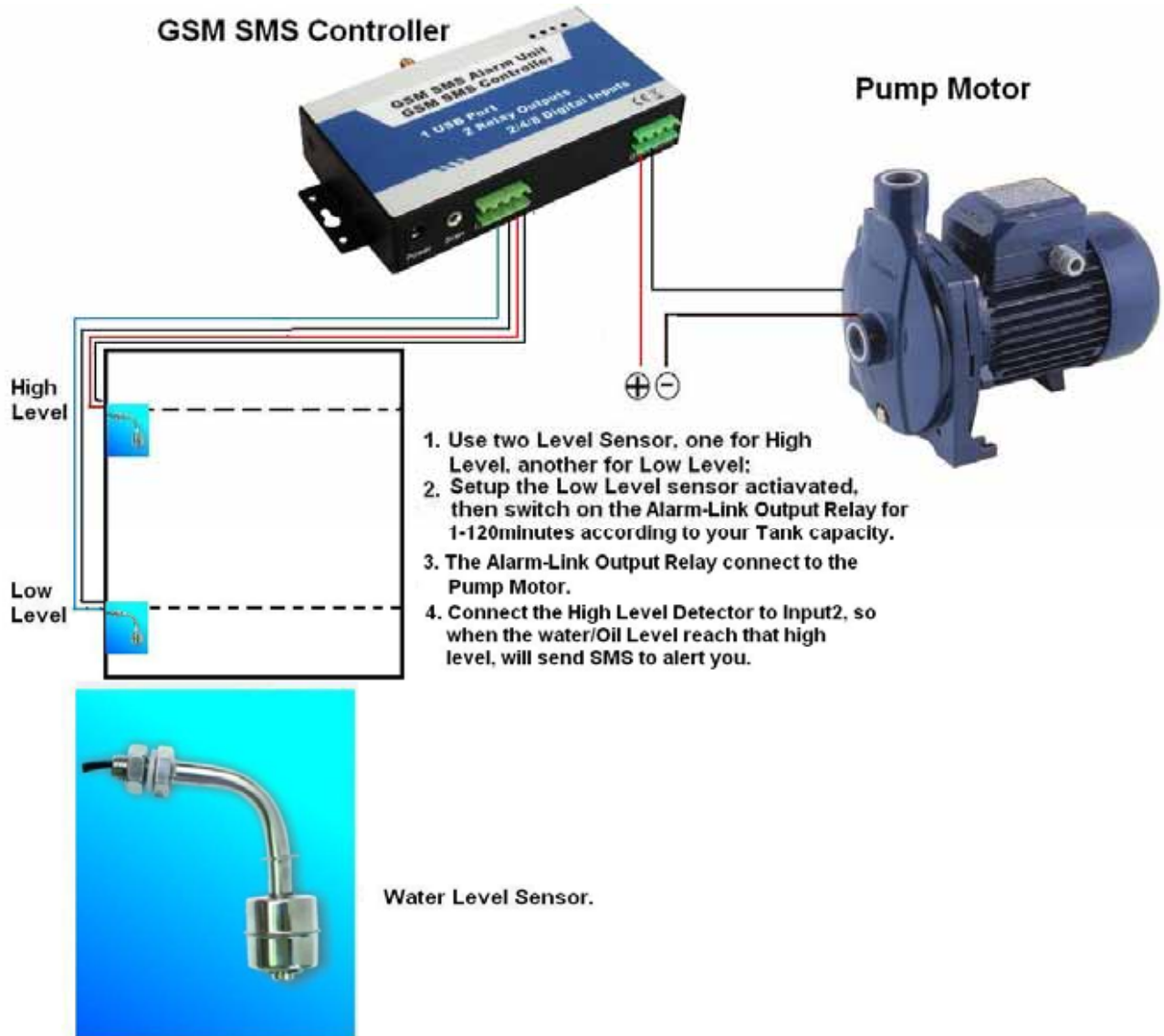

Application Sample 3

Environment Condition Monitoring Solution

This solution is suitable for environment condition monitoring, when the temperature or humidity exceed the pre set value, the air conditioner will switch on. Also, the user can use the SMS Command to switch on or switch off the air conditioner when use the independent output relay. This solution is suitable for lots of other similar monitoring applications.

GSM Environment Condition Monitoring Solution

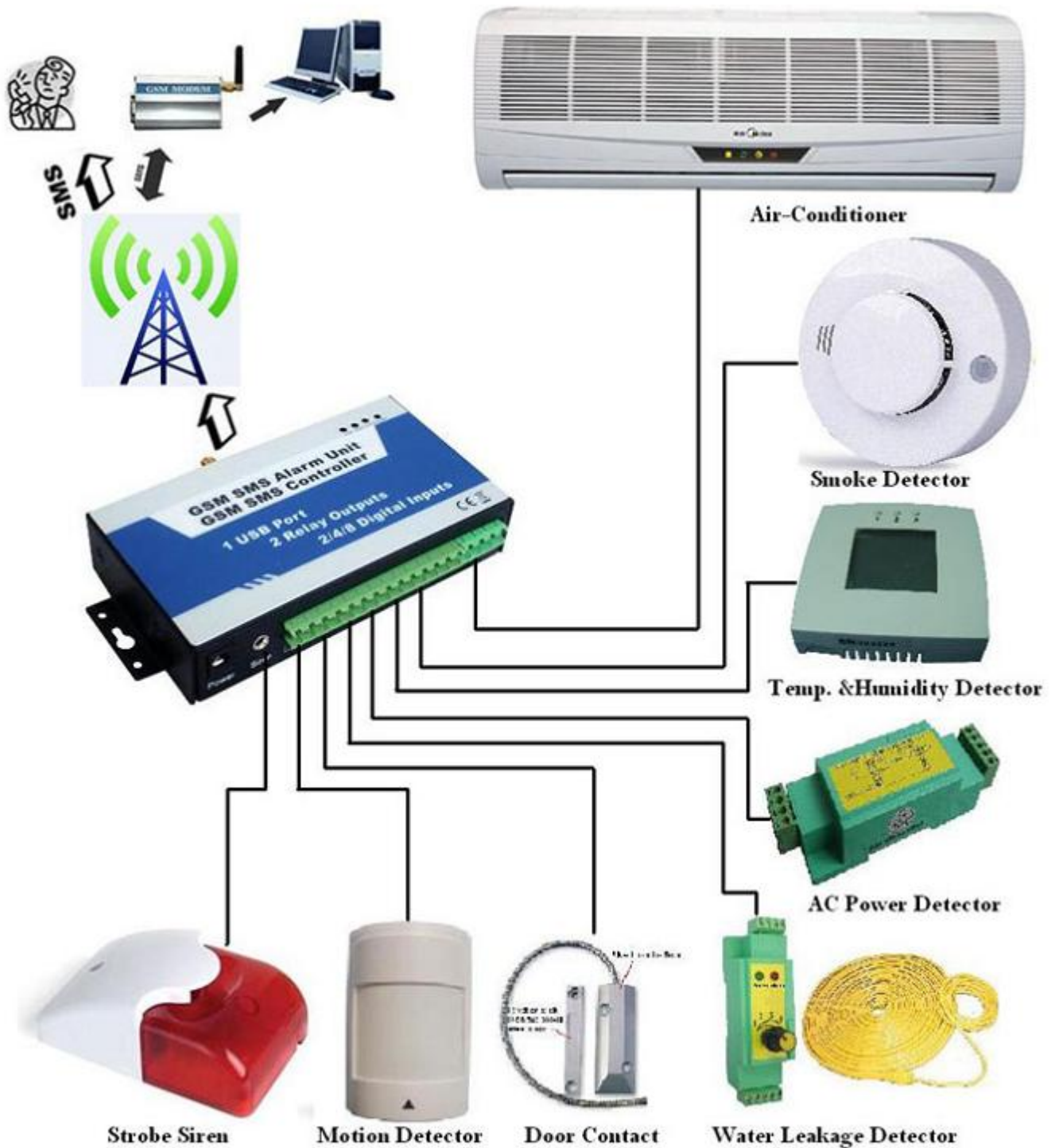

8.3 Install the Mainframe

The mainframe should be installed in the position that person can not get it, and there're with a power source as well as enough GSM signal coverage.

8.4 Install the Speak and Microphone to the Mainframe

The GSM SMS Controller allows the authorized users call in to create two way voice communications, also, when the system alarm, the authorized number can listen in the on-site sounds.



While you install the Microphone and Speaker, please make sure keep it away from the GSM SMS Controller at least 1 meters and far from the siren if possible.

9. Technical specifications

Rated Voltage: 12VDC @ 2A

Working temperature: -10 ~ +60

Storage temperature: -20 ~ +60

Relative humidity: 10-90%, No condensation

GSM frequency: 850/900/1800/1900Mhz

Communication protocol: GSM PHASE 2/2+ (include data service)

Digital inputs: 2 / 4 / 8

Backup Rechargeable Battery: 24Hours in standby mode.

Related Voltage of the Output Relay: 3A/240V AC

Net Weight: 0.60Kg

10. Warranty

- 1) This system is warranted to be free of defects in material and workmanship for one year from the date of purchase.
- 2) This warranty does not extend to any defect, malfunction or failure caused by abuse or misuse by the Operating Instructions. In no event shall the manufacturer be liable for any alarm system altered by purchasers.

11. Trouble Shooting Guide

PROBLEM	CAUSE	POSSIBLE SOLUTION
GSM Module initialization failed	1) Backup battery with low voltage; GSM Module connection loose in transportation; 2) GSM Signal is too weak.	1) Please contact the AC Power; 2) Please help to take the panel to a mobile phone repairmen store, and then ask the engineer to check the GSM Module socket and the GSM Module connection; 3) Please change another position to install the alarm panel.
Automatically Restart	1) Backup battery with low voltage.	1) Please help to contact the AC Power.
False Alarm	1) PIR Motion detector installation incorrect; 2) NC/NO/EOL is incorrect.	1) Please see the PIR Motion detector installation user manual carefully; 2) Please check the detector NC/NO type, and you're sure connect a 2.2K Resistor in series in the un-use input ports.
Alarm without SMS /Dial/ No action after send SMS	1) GSM Operator communication protocol; 2) Haven't setup SMS Alert/Auto dial Numbers. 3) Caps Lock letters in the SMS.	1) Please setup the SMS Alert Numbers; 2) Please help to see the sample of setup the telephone numbers; 3) Please check the commands with CAPS LOCK and correct format. 4) Also, please help to change another GSM Operator SIMCard to test it.